

Part Number: KM2520QBC-D03

Blue



**ATTENTION**  
OBSERVE PRECAUTIONS  
FOR HANDLING  
ELECTROSTATIC  
DISCHARGE  
SENSITIVE  
DEVICES

### Features

- Subminiature package.
- Gull wing lead.
- Long life - solid state reliability.
- Low package profile.
- Moisture sensitivity level : level 3.
- Package : 1000pcs / reel.
- RoHS compliant.

### Description

The Blue source color devices are made with InGaN Light Emitting Diode.

Static electricity and surge damage the LEDs.

It is recommended to use a wrist band or anti-electrostatic glove when handling the LEDs.

All devices, equipment and machinery must be electrically grounded.

### Package Dimensions

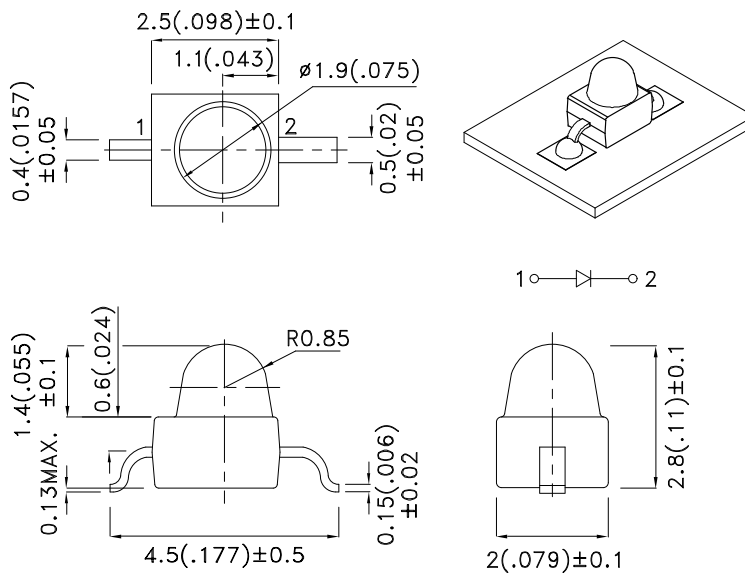

#### Notes:

1. All dimensions are in millimeters (inches).
2. Tolerance is  $\pm 0.25(0.01)$ " unless otherwise noted.
3. Lead spacing is measured where the leads emerge from the package.
4. The specifications, characteristics and technical data described in the datasheet are subject to change without prior notice.
5. The device has a single mounting surface. The device must be mounted according to the specifications.



## Selection Guide

| Part No.      | Dice         | Lens Type   | Iv (mcd) [2]<br>@ 20mA |      | Viewing<br>Angle [1] |
|---------------|--------------|-------------|------------------------|------|----------------------|
|               |              |             | Min.                   | Typ. | 2θ1/2                |
| KM2520QBC-D03 | Blue (InGaN) | Water Clear | 350                    | 600  | 20°                  |

Notes:

1. θ1/2 is the angle from optical centerline where the luminous intensity is 1/2 of the optical peak value.
2. Luminous intensity/ luminous Flux: +/-15%.

## Electrical / Optical Characteristics at TA=25°C

| Symbol             | Parameter                | Device | Typ. | Max. | Units | Test Conditions           |
|--------------------|--------------------------|--------|------|------|-------|---------------------------|
| λ <sub>peak</sub>  | Peak Wavelength          | Blue   | 468  |      | nm    | I <sub>F</sub> =20mA      |
| λ <sub>D</sub> [1] | Dominant Wavelength      | Blue   | 470  |      | nm    | I <sub>F</sub> =20mA      |
| Δλ <sub>1/2</sub>  | Spectral Line Half-width | Blue   | 25   |      | nm    | I <sub>F</sub> =20mA      |
| C                  | Capacitance              | Blue   | 100  |      | pF    | V <sub>F</sub> =0V;f=1MHz |
| V <sub>F</sub> [2] | Forward Voltage          | Blue   | 3.3  | 4    | V     | I <sub>F</sub> =20mA      |
| I <sub>R</sub>     | Reverse Current          | Blue   |      | 50   | uA    | V <sub>R</sub> =5V        |

Notes:

1. Wavelength: +/-1nm.
2. Forward Voltage: +/-0.1V.

## Absolute Maximum Ratings at TA=25°C

| Parameter                | Blue           | Units |
|--------------------------|----------------|-------|
| Power dissipation        | 120            | mW    |
| DC Forward Current       | 30             | mA    |
| Peak Forward Current [1] | 150            | mA    |
| Reverse Voltage          | 5              | V     |
| Operating Temperature    | -40°C To +85°C |       |
| Storage Temperature      | -40°C To +85°C |       |

Note:

1. 1/10 Duty Cycle, 0.1ms Pulse Width.

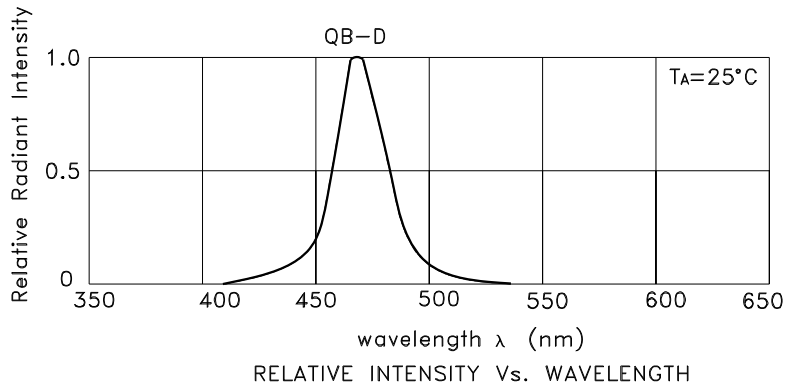

**Blue**

**KM2520QBC-D03**

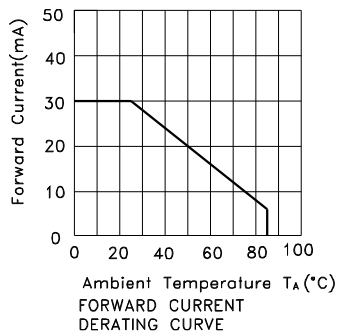
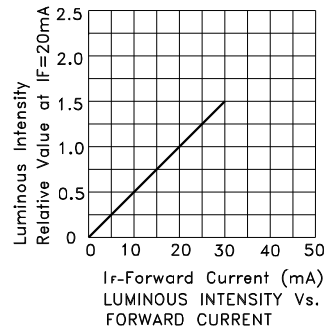
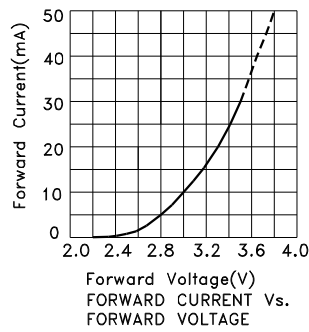

## KM2520QBC-D03

Reflow soldering is recommended and the soldering profile is shown below.  
Other soldering methods are not recommended as they might cause damage to the product.

Reflow Soldering Profile For Lead-free SMT Process.



NOTES:

1. We recommend the reflow temperature 245°C (+/-5°C). The maximum soldering temperature should be limited to 260°C.
2. Don't cause stress to the epoxy resin while it is exposed to high temperature.
3. Number of reflow process shall be 2 times or less.

### Recommended Soldering Pattern (Units : mm; Tolerance: ± 0.1)

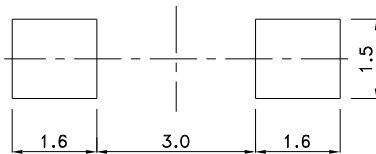

### Reel Dimension



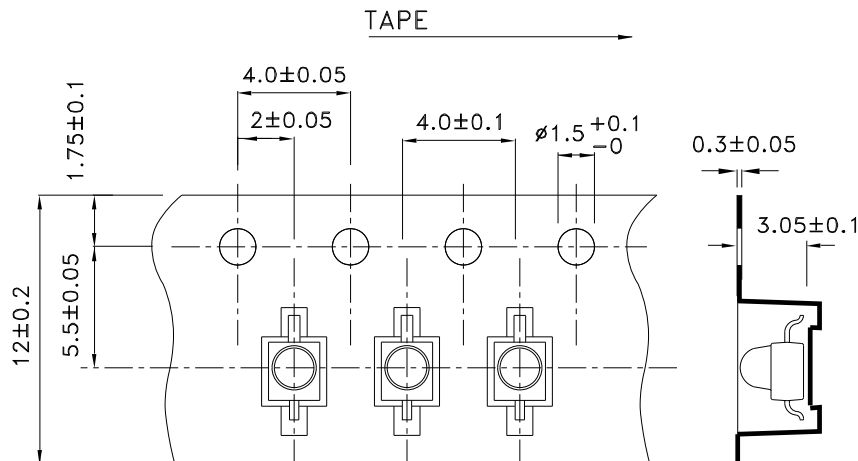

### Tape Dimensions (Units : mm)

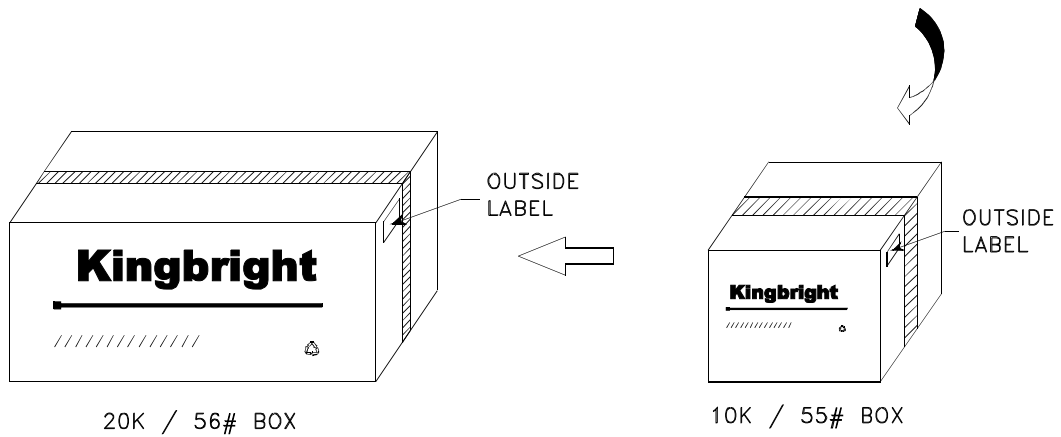
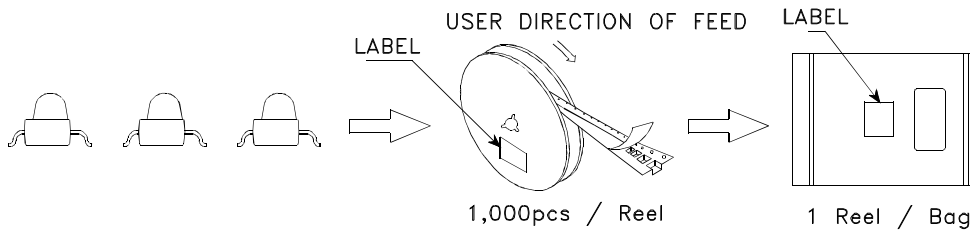

**PACKING & LABEL SPECIFICATIONS**

**KM2520QBC-D03**



|   |      |                             |
|---|------|-----------------------------|
| <h1 style="margin: 0;">Kingbright</h1>  |      |                             |
| P/NO: KM2520xxx   |      |                             |
| QTY: 1000 pcs   | Q.C. | Q C<br>XX XX XXXX<br>PASSED |
| S/N: XXXX   |      |                             |
| CODE: XXX   |      |                             |
| LOT NO:   |      |                             |
| <br><small>xxxxxxxxxxxxxxxxxxxxxxxxxxxxxxxx</small> |      |                             |
| RoHS Compliant  |      |                             |