

Part Number: L-59SRSGC-CC

Super Bright Red
Super Bright Green

Features

- Uniform light output.
- Low power consumption.
- 3 leads with one common lead.
- Long life-solid state reliability.
- RoHS compliant.

Description

The Super Bright Red source color devices are made with Gallium Aluminum Arsenide Red Light Emitting Diode.
The Super Bright Green source color devices are made with Gallium Phosphide Green Light Emitting Diode.

Package Dimensions

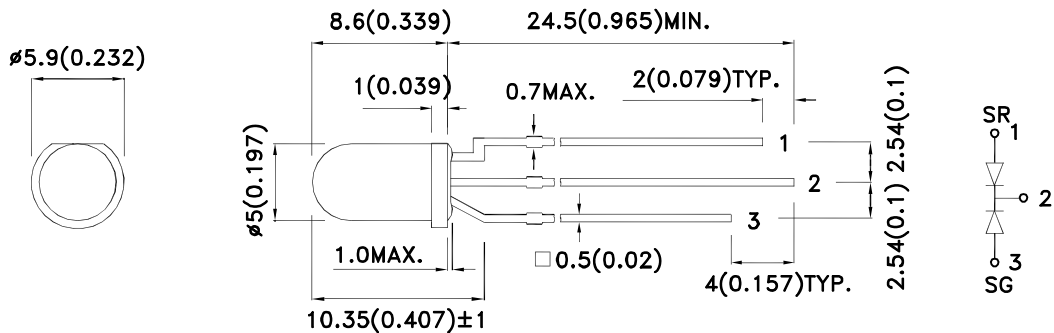

- 1 ANODE RED
- 2 COMMON CATHODE
- 3 ANODE GREEN

Notes:

1. All dimensions are in millimeters (inches).
2. Tolerance is $\pm 0.25(0.01)$ " unless otherwise noted.
3. Lead spacing is measured where the leads emerge from the package.
4. The specifications, characteristics and technical data described in the datasheet are subject to change without prior notice.



Selection Guide

Part No.	Dice	Lens Type	Iv (mcd) [2] @ 20mA		Viewing Angle [1]
			Min.	Typ.	2θ1/2
L-59SRSGC-CC	Super Bright Red (GaAlAs)	WATER CLEAR	280	600	24°
	Super Bright Green (GaP)		70	200	

Notes:

1. θ1/2 is the angle from optical centerline where the luminous intensity is 1/2 of the optical peak value.
2. Luminous intensity/ luminous Flux: +/-15%.

Electrical / Optical Characteristics at TA=25°C

Symbol	Parameter	Device	Typ.	Max.	Units	Test Conditions
λpeak	Peak Wavelength	Super Bright Red Super Bright Green	660 565		nm	IF=20mA
λD [1]	Dominant Wavelength	Super Bright Red Super Bright Green	640 568		nm	IF=20mA
Δλ1/2	Spectral Line Half-width	Super Bright Red Super Bright Green	20 30		nm	IF=20mA
C	Capacitance	Super Bright Red Super Bright Green	45 15		pF	VF=0V;f=1MHz
VF [2]	Forward Voltage	Super Bright Red Super Bright Green	1.85 2.2	2.5 2.5	V	IF=20mA
IR	Reverse Current	Super Bright Red Super Bright Green		10 10	uA	VR = 5V

Notes:

1. Wavelength: +/-1nm.
2. Forward Voltage: +/-0.1V.

Absolute Maximum Ratings at TA=25°C

Parameter	Super Bright Red	Super Bright Green	Units
Power dissipation	75	62.5	mW
DC Forward Current	30	25	mA
Peak Forward Current [1]	155	140	mA
Reverse Voltage	5		V
Operating / Storage Temperature	-40°C To +85°C		
Lead Solder Temperature [2]	260°C For 3 Seconds		
Lead Solder Temperature [3]	260°C For 5 Seconds		

Notes:

1. 1/10 Duty Cycle, 0.1ms Pulse Width.
2. 2mm below package base.
3. 5mm below package base.

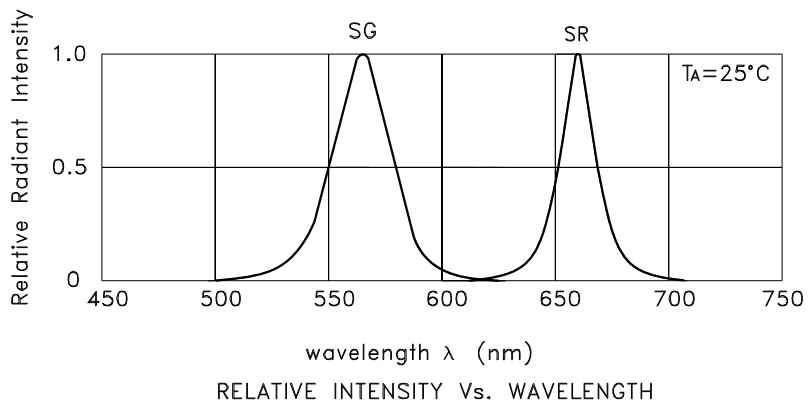

L-59SRSGC-CC Super Bright Red

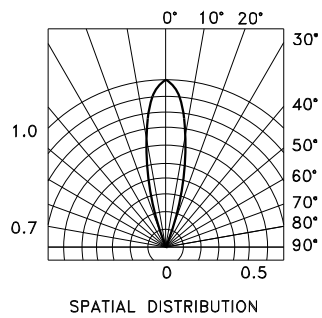
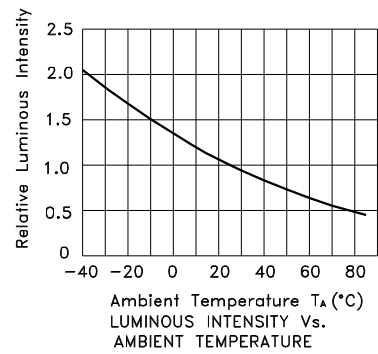
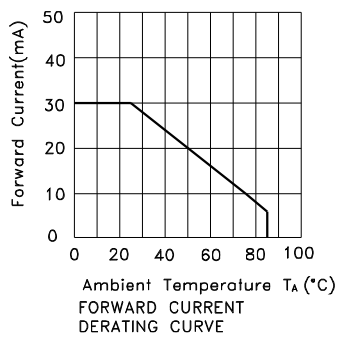
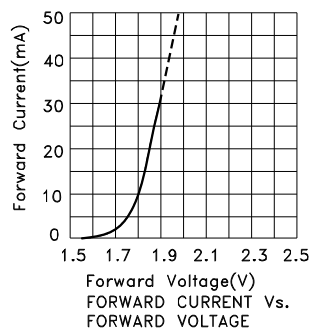

Super Bright Green

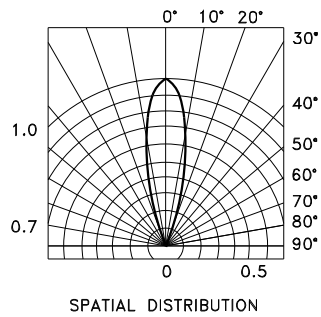
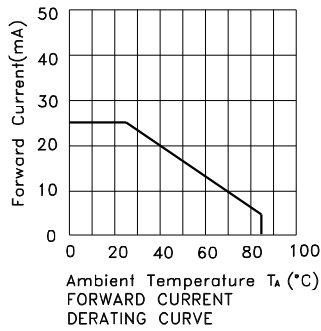
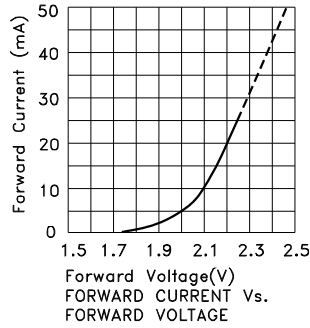

Kingbright

PACKING & LABEL SPECIFICATIONS

L-59SRSGC-CC

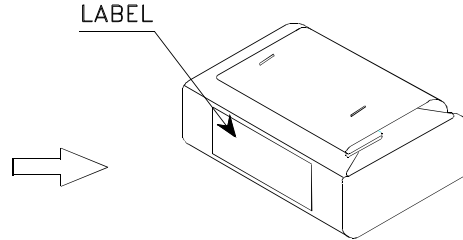
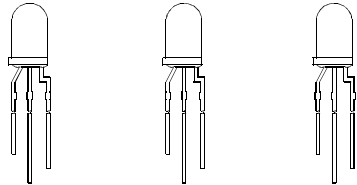

500PCS / BAG



28K / 9# BOX

OUTSIDE LABEL

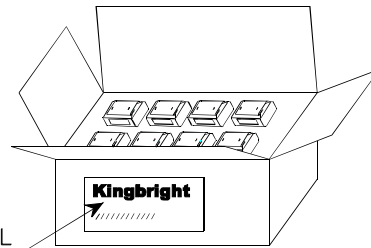
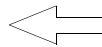

OUTSIDE LABEL

14K / 5# BOX

Kingbright

P/N0: L-59xxx

QTY: 500 pcs

Q.C.

S/N: XXXX

CODE: XXX



LOT NO:



RoHS Compliant

LED MOUNTING METHOD

1. The lead pitch of the LED must match the pitch of the mounting holes on the PCB during component placement. Lead-forming may be required to insure the lead pitch matches the hole pitch. Refer to the figure below for proper lead forming procedures.

(Fig. 1)

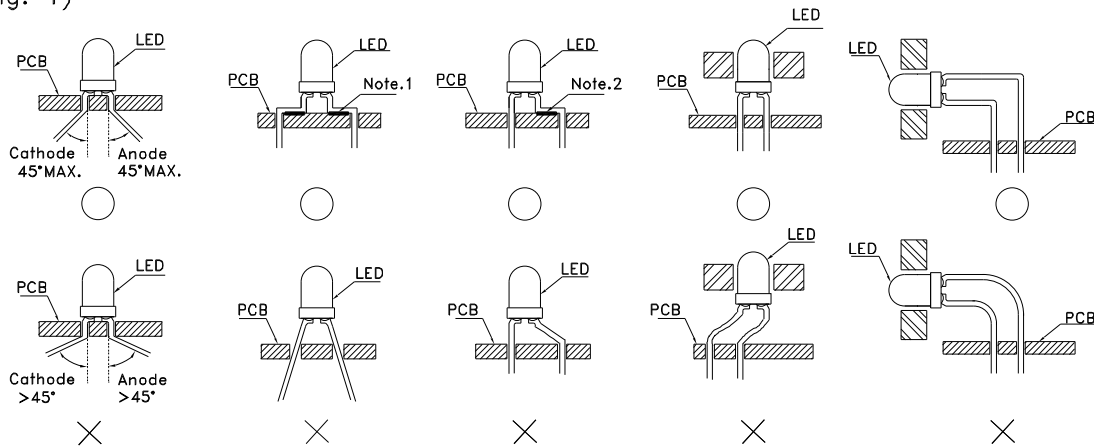

Fig.1

”O” Correct mounting method ”X” Incorrect mounting method

Note 1-2 : Do not route PCB trace in the contact area between the leadframe and the PCB to prevent short-circuits.

2. When soldering wire to the LED, use individual heat-shrink tubing to insulate the exposed leads to prevent accidental contact short-circuit.

(Fig. 2)

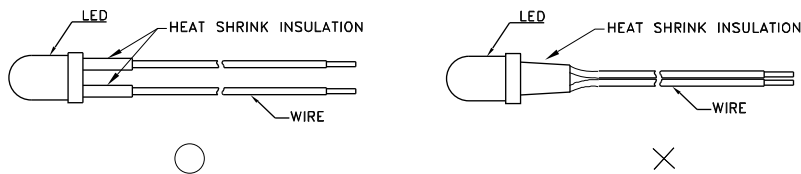

Fig. 2

3. Use stand-offs (Fig. 3) or spacers (Fig. 4) to securely position the LED above the PCB.

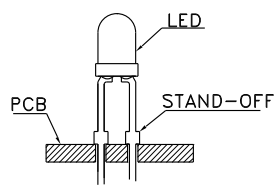

Fig. 3

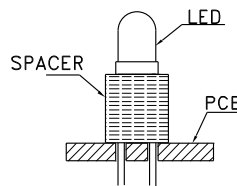

Fig. 4

LEAD FORMING PROCEDURES

1. Maintain a minimum of 2mm clearance between the base of the LED lens and the first lead bend. (Fig. 5 and 6)

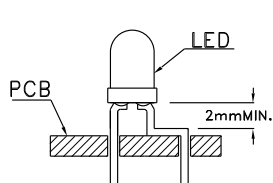

Fig. 5

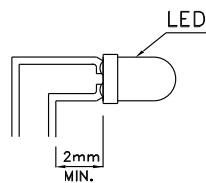

Fig. 6

2. Lead forming or bending must be performed before soldering, never during or after Soldering.
3. Do not stress the LED lens during lead-forming in order to fractures in the lens epoxy and damage the internal structures.
4. During lead forming, use tools or jigs to hold the leads securely so that the bending force will not be transmitted to the LED lens and its internal structures. Do not perform lead forming once the component has been mounted onto the PCB. (Fig. 7)
5. Do not bend the leads more than twice. (Fig. 8)

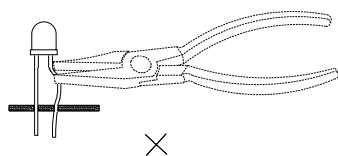

Fig. 7

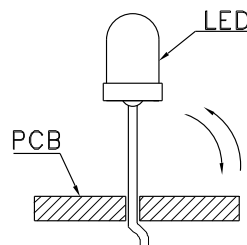

Fig. 8

6. After soldering or other high-temperature assembly, allow the LED to cool down to 50°C before applying outside force (Fig. 9). In general, avoid placing excess force on the LED to avoid damage. For any questions please consult with Kingbright representative for proper handling procedures.

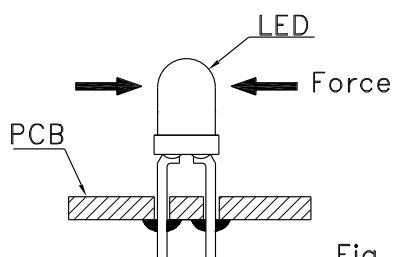

Fig. 9