

Konektor PBS - PBD

Technické parametry:

Jmenovitý proud (max.): 3 A

Maximální napětí: 250 V ~ po dobu 1 minuty

Izolační odpor: min. 1000 M Ω při 1000 V = po dobu 1 minuty

Teplotní rozsah: -25°C až +125°C

Materiál kontaktů: fosforbronz nebo mosaz

Materiál izolátoru: Polyester UL 94 V-0

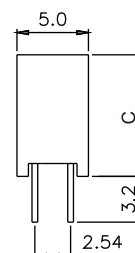
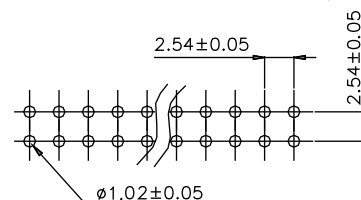
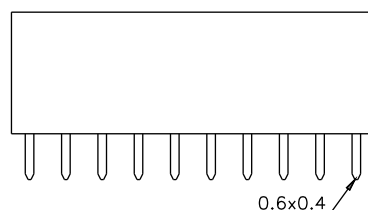
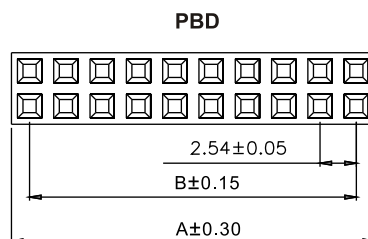
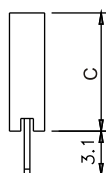
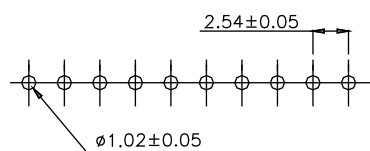
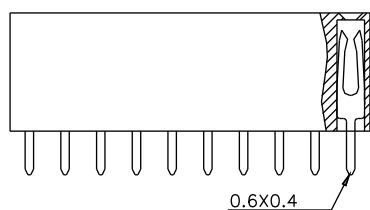
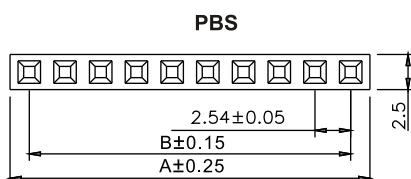
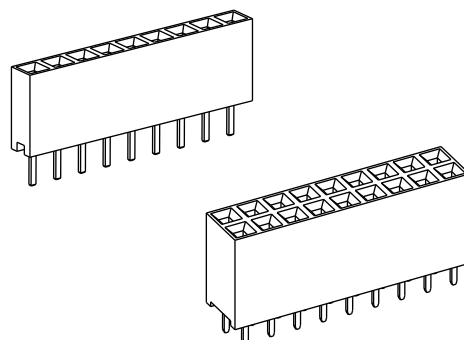

Objed. číslo	Popis	Rozměry (mm)		
		A	B	C
PBS 05 R-85	5 pinů	13,20	10,16	8,5
PBS 10 R-85	10 pinů	25,90	22,86	8,5
PBS 15 R-85	15 pinů	38,60	35,56	8,5
PBS 20 R-85	20 pinů	51,30	48,26	8,5
PBS 05 S-85	5 pinů	13,20	10,16	8,5
PBS 10 S-85	10 pinů	25,90	22,86	8,5
PBS 20 S-85	20 pinů	51,30	48,26	8,5
PBD 40 R-85	2 x 20	51,50	48,26	8,5
PBD 44 R-85	2 x 22	54,04	50,80	8,5
PBD 10 S-85	2 x 5	13,40	10,16	8,5
PBD 20 S-85	2 x 10	26,10	22,86	8,5
PBD 40 S-85	2 x 20	51,50	48,26	8,5

* jiné počty kontaktů na objednávku