

CIRCUIT	PART NO.	DIM A	COLOR
2	171692-0202	8.35	BLACK
4	171692-0204	12.05	
6	171692-0206	17.75	
8	171692-0208	23.45	
10	171692-0210	29.15	
12	171692-0212	34.85	

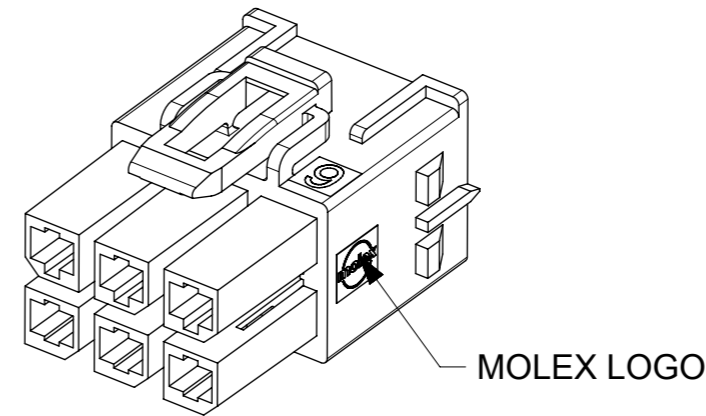

NOTES:

- MATERIAL:**
 NYLON, UL 94V-0 AND GLOW WIRE CAPABLE PER IEC60335-1.
 COLOR: BLACK.
- PART USED WITH MOLEX SERIES:**
 HEADER: 76829, 172065; 76825, 172064
 PLUG: 105411
 TPA-CAPABLE FEMALE TERMINAL: 76823-034X OR 172063-033X OR 172063-133X
 TPA: 105415
- PRODUCT SPECIFICATION:** 1054171000-PS/1720631000-PS.
- PAKAGING SPECIFICATION:** 1716920200.
- APPLICATION SPECIFICATION:** 768232000-AS

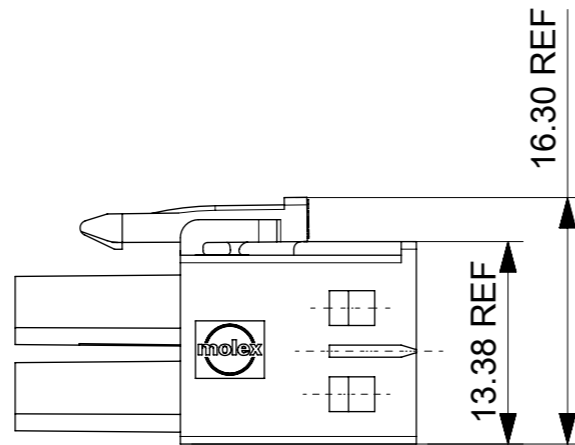
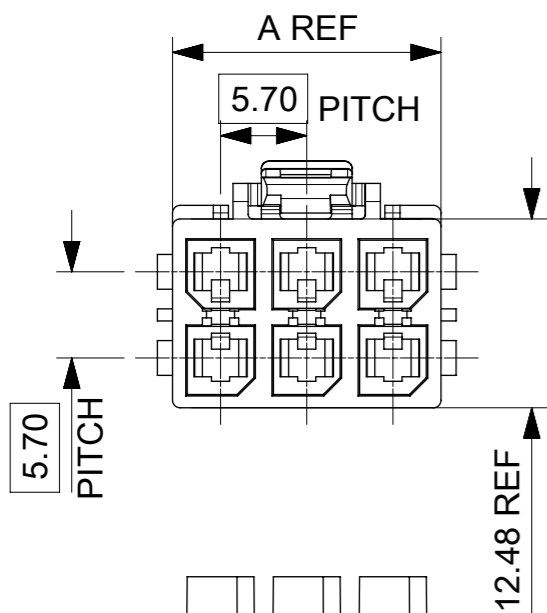
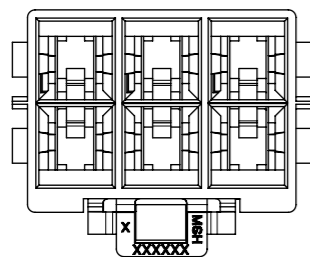
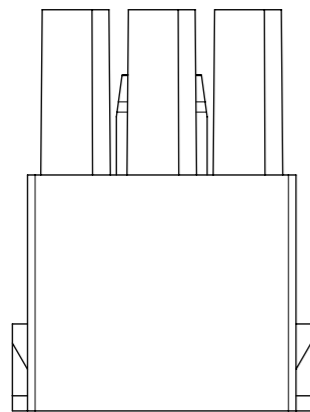

THIS DRAWING CONTAINS INFORMATION THAT IS PROPRIETARY TO MOLEX ELECTRONIC TECHNOLOGIES, LLC AND SHOULD NOT BE USED WITHOUT WRITTEN PERMISSION									
DIMENSION UNITS		SCALE		CURRENT REV DESC:				molex	
mm		NTS							
GENERAL TOLERANCES (UNLESS SPECIFIED)				EC NO: 755658				MEGA-FIT RECEPTACLE DR TPA	
ANGULAR TOL ± 3.0 °				DRWN: WYATTH5 2023/07/04					
4 PLACES ±				CHK'D: XQZHANG 2023/07/24				PRODUCT CUSTOMER DRAWING	
3 PLACES ±				APPR: XQZHANG 2023/07/24					
2 PLACES ± 0.25				INITIAL REVISION:				DOCUMENT NUMBER	
1 PLACE ± 0.35				DRWN: YXZHENG 2016/12/15				1716920200	
0 PLACES ±				APPR: YXZHENG 2018/08/06				DOC TYPE DOC PART REVISION	
DRAFT WHERE APPLICABLE MUST REMAIN WITHIN DIMENSIONS				THIRD ANGLE PROJECTION		DRAWING		SHEET NUMBER	
				A3-SIZE		SERIES		MATERIAL NUMBER	
						171692		CUSTOMER	
						SEE TABLE		GENERAL MARKET	

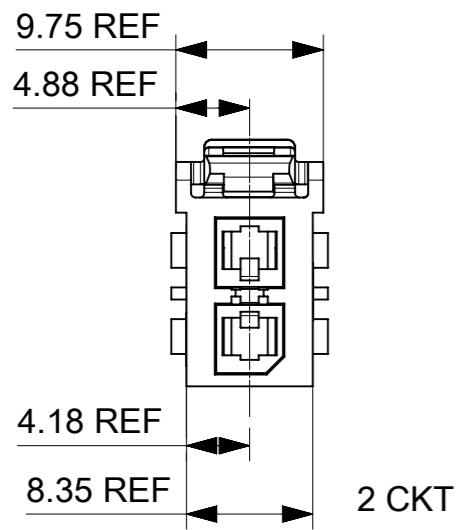

2 CKT

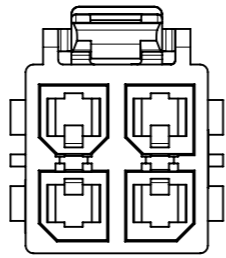
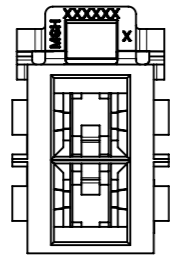

4 CKT

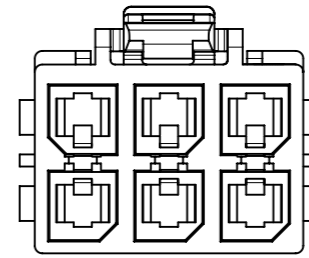
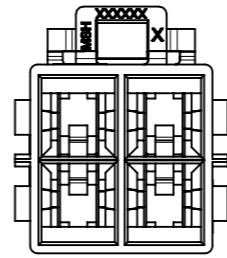

6 CKT

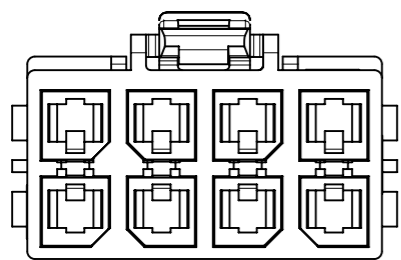
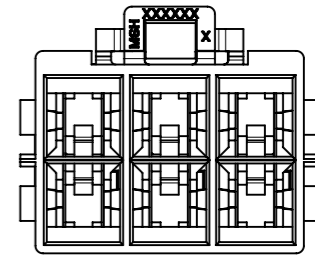

8 CKT

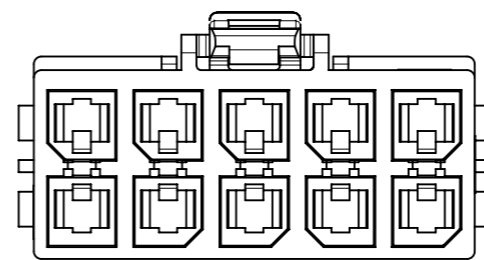
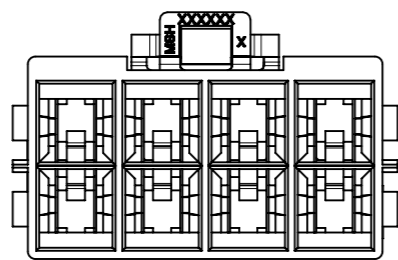

10 CKT

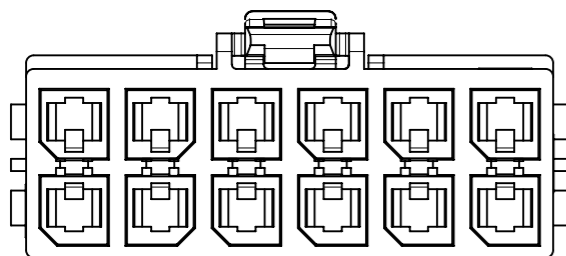
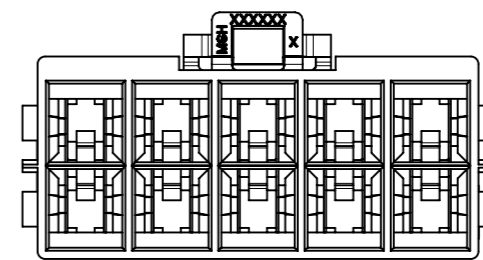

12 CKT

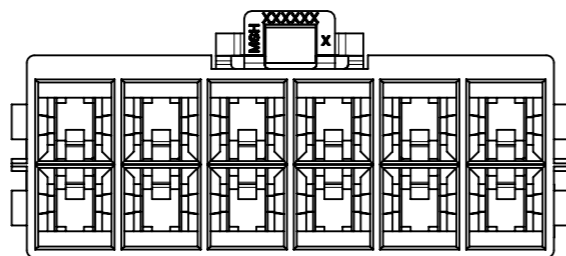

THIS DRAWING CONTAINS INFORMATION THAT IS PROPRIETARY TO MOLEX ELECTRONIC TECHNOLOGIES, LLC AND SHOULD NOT BE USED WITHOUT WRITTEN PERMISSION									
DIMENSION UNITS	SCALE	CURRENT REV DESC:							
mm	NTS								
GENERAL TOLERANCES (UNLESS SPECIFIED)		EC NO: 755658			MEGA-FIT RECEPTACLE DR TPA				
ANGULAR TOL ± 3.0 °		DRWN: WYATTH5 2023/07/04							
4 PLACES	±	CHK'D: XQZHANG 2023/07/24			PRODUCT CUSTOMER DRAWING				
3 PLACES	±	APPR: XQZHANG 2023/07/24							
2 PLACES	± 0.25	INITIAL REVISION:			DOCUMENT NUMBER: 1716920200 DOC TYPE: PSD DOC PART: 000 REVISION: E2				
1 PLACE	± 0.35	DRWN: YXZHENG 2016/12/15							
0 PLACES	±	APPR: YXZHENG 2018/08/06			MATERIAL NUMBER: SEE TABLE CUSTOMER: GENERAL MARKET SHEET NUMBER: 2 OF 2				
DRAFT WHERE APPLICABLE MUST REMAIN WITHIN DIMENSIONS		THIRD ANGLE PROJECTION	DRAWING	SERIES					
			A3-SIZE	171692					