

CIRCUIT	PART NO.	DIM A	COLOR
2	171692-0202	8.35	BLACK
4	171692-0204	12.05	
6	171692-0206	17.75	
8	171692-0208	23.45	
10	171692-0210	29.15	
12	171692-0212	34.85	

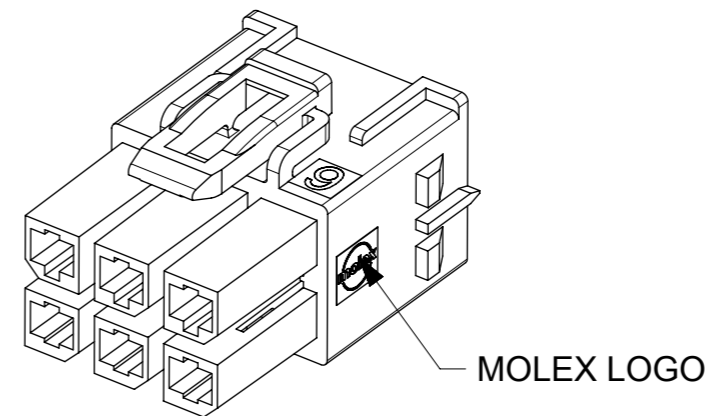

NOTES:

- MATERIAL:**
 NYLON, UL 94V-0 AND GLOW WIRE CAPABLE PER IEC60335-1.
 COLOR: BLACK.
- PART USED WITH MOLEX SERIES:**
 HEADER: 76829, 172065; 76825, 172064
 PLUG: 105411
 TPA-CAPABLE FEMALE TERMINAL: 76823-034X OR 172063-033X OR 172063-133X
 TPA: 105415
- PRODUCT SPECIFICATION:** 1054171000-PS/1720631000-PS.
- PAKAGING SPECIFICATION:** 1716920200.
- APPLICATION SPECIFICATION:** 768232000-AS

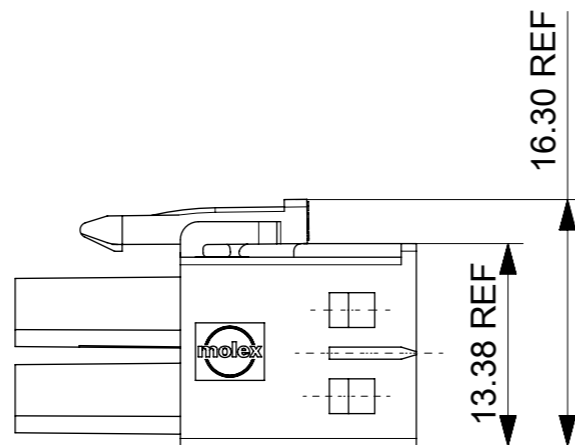
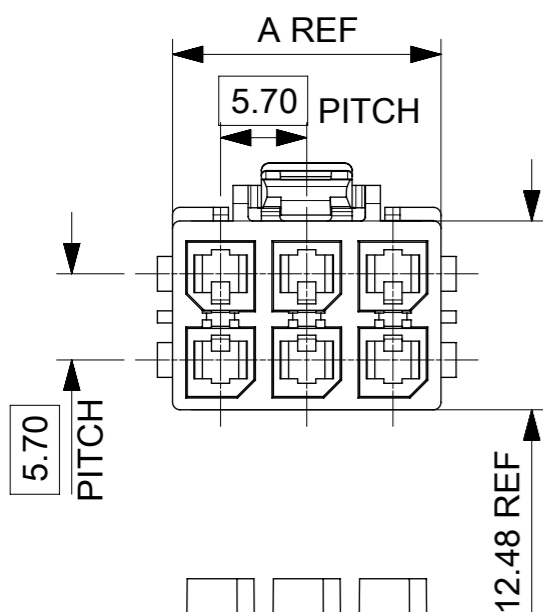
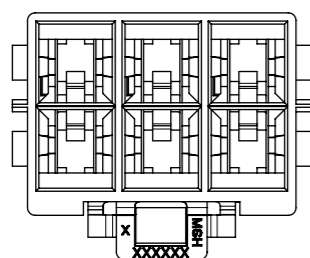
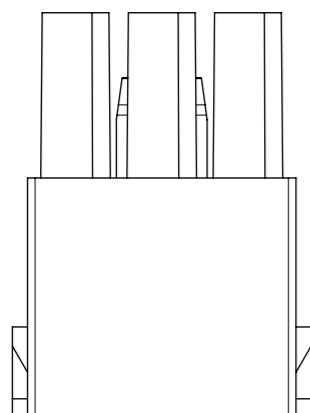

THIS DRAWING CONTAINS INFORMATION THAT IS PROPRIETARY TO MOLEX ELECTRONIC TECHNOLOGIES, LLC AND SHOULD NOT BE USED WITHOUT WRITTEN PERMISSION									
DIMENSION UNITS		SCALE		CURRENT REV DESC:				molex	
mm		NTS							
GENERAL TOLERANCES (UNLESS SPECIFIED)									
ANGULAR TOL ± 3.0°									
4 PLACES		±		EC NO: 755658		2023/07/04		MEGA-FIT RECEPTACLE DR TPA	
3 PLACES		±		DRWN: WYATTH5		2023/07/24			
2 PLACES		± 0.25		CHK'D: XQZHANG		2023/07/24			
1 PLACE		± 0.35		APPR: XQZHANG		2023/07/24		PRODUCT CUSTOMER DRAWING	
0 PLACES		±		INITIAL REVISION:				DOCUMENT NUMBER	
				DRWN: YXZHENG		2016/12/15		1716920200	
				APPR: YXZHENG		2018/08/06		PSD 000 E2	
DRAFT WHERE APPLICABLE MUST REMAIN WITHIN DIMENSIONS		THIRD ANGLE PROJECTION		DRAWING		SERIES		MATERIAL NUMBER	
				A3-SIZE		171692		SEE TABLE	
								CUSTOMER	
								GENERAL MARKET	
								SHEET NUMBER	
								1 OF 2	

9.75 REF
 4.88 REF
 4.18 REF
 8.35 REF

2 CKT

4 CKT

6 CKT

8 CKT

10 CKT

12 CKT

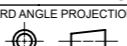
THIS DRAWING CONTAINS INFORMATION THAT IS PROPRIETARY TO MOLEX ELECTRONIC TECHNOLOGIES, LLC AND SHOULD NOT BE USED WITHOUT WRITTEN PERMISSION									
DIMENSION UNITS	SCALE	CURRENT REV DESC:			 MEGA-FIT RECEPTACLE DR TPA				
mm	NTS								
GENERAL TOLERANCES (UNLESS SPECIFIED)		EC NO: 755658			DOCUMENT NUMBER				
ANGULAR TOL ± 3.0°		DRWN: WYATTH5			DOC TYPE				
4 PLACES ±		CHK'D: XQZHANG			DOC PART				
3 PLACES ±		APPR: XQZHANG			REVISION				
2 PLACES ± 0.25		INITIAL REVISION:			1716920200				
1 PLACE ± 0.35		DRWN: YXZHENG			PSD				
0 PLACES ±		APPR: YXZHENG			000				
DRAFT WHERE APPLICABLE MUST REMAIN WITHIN DIMENSIONS		THIRD ANGLE PROJECTION		DRAWING		SERIES		SHEET NUMBER	
				A3-SIZE		171692		2 OF 2	

DOCUMENT STATUS	P1	RELEASE DATE	2023/07/24	06:40:45
-----------------	----	--------------	------------	----------

FORMAT: master-ib-prod-A3
 REVISION: 11
 DATE: 2021/05/01