

Infrared Transceiver Module (SIR, 115.2 kbit/s) for IrDA® Applications

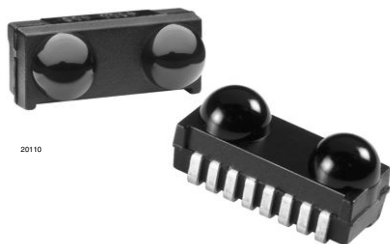

DESCRIPTION

The TFDU4101 transceiver is an infrared transceiver module compliant to the latest IrDA® physical layer standard for fast infrared data communication, supporting IrDA speeds up to 115.2 kbit/s (SIR), and carrier based remote control modes. Integrated within the transceiver module are a photo pin diode, an infrared emitter (IRED), and a low-power control IC to provide a total front-end solution in a single package. This device covers the full IrDA range of more than 1 m using the internal intensity control. With one external current control resistor the current can be adjusted for shorter ranges saving operating current operating in IrDA low power mode. This Vishay SIR transceiver is using the lead frame technology.

The receiver output pulse duration is independent of the optical input pulse duration and recovers always a fixed pulse duration optimum for compatibility to standard Endecs and interfaces. TFDU4101 has a tristate output and is floating in shutdown mode with a weak pull-up.

FEATURES

- Operates from 2.4 V to 5.5 V within specification over full temperature range from -30 °C to +85 °C
- Split power supply, transmitter and receiver can be operated from two power supplies with relaxed requirements saving costs, US - patent no. 6,157,476
- Low power consumption (< 0.12 mA supply current in receive mode, no signal)
- Power shutdown mode (< 4 µA shutdown current in full temperature range, up to 85 °C, < 10 nA at 25 °C)
- Surface mount package (L x W x H in mm): 9.7 × 4.7 × 4
- High efficiency emitter
- Low profile (universal) package capable of surface mount soldering to side and top view orientation
- Directly Interfaces with various super I/O and controller devices as e. g. TOIM4232
- Tri-state-receiver output, floating in shut down with a weak pull-up
- Qualified for lead (Pb)-free and Sn/Pb processing (MSL4)
- Material categorization: For definitions of compliance please see www.vishay.com/doc?99912

APPLICATIONS

- Printers, fax machines, photocopiers, screen projectors
- Internet TV boxes, video conferencing systems
- Medical data collection
- Diagnostic systems
- Notebook computers, desktop PCs, palmtop computers (Win CE, Palm PC), PDAs
- Internet TV boxes, video conferencing systems
- External infrared adapters (dongles)
- Data loggers
- GPS
- Kiosks, POS, point and pay devices
- Industrial applications

PRODUCT SUMMARY

PART NUMBER	DATA RATE (kbit/s)	DIMENSIONS H x L x W (mm x mm x mm)	LINK DISTANCE (m)	OPERATING VOLTAGE (V)	IDLE SUPPLY CURRENT (mA)
TFDU4101	115.2	4 x 9.7 x 4.7	0 to ≥ 1	2.4 to 5.5	0.07

PARTS TABLE

PART	DESCRIPTION	QTY/REEL
TFDU4101-TR3	Oriented in carrier tape for side view surface mounting	1000 pcs
TFDU4101-TT3	Oriented in carrier tape for top view surface mounting	1000 pcs

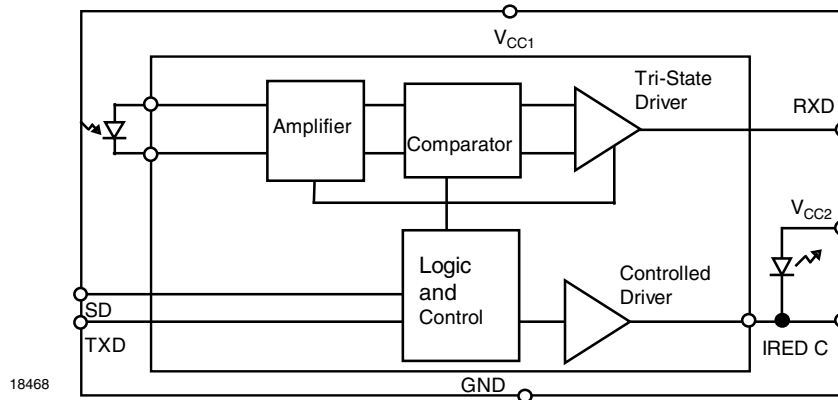
FUNCTIONAL BLOCK DIAGRAM

18468

PIN DESCRIPTION				
PIN NUMBER	SYMBOL	DESCRIPTION	I/O	ACTIVE
1	V_{CC2} IRED anode	IRED anode to be externally connected to V_{CC2} . An external resistor is only necessary for controlling the IRED current when a current reduction below 300 mA is intended to operate in IrDA low power mode. This pin is allowed to be supplied from an uncontrolled power supply separated from the controlled V_{CC1} - supply.		
2	IRED cathode	IRED cathode, internally connected to driver transistor		
3	TXD	This Schmitt-Trigger input is used to transmit serial data when SD is low. An on-chip protection circuit disables the LED driver if the TXD pin is asserted for longer than 50 μ s (max. 300 μ s).	I	High
4	RXD	Received data output, push-pull CMOS driver output capable of driving standard CMOS or TTL loads. During transmission the RXD output is active (echo-on). No external pull-up or pull-down resistor is required. Floating with a weak pull-up of 500 k Ω (typ.) in shutdown mode.	O	Low
5	SD	Shutdown	I	High
6	V_{CC1}	Supply voltage		
7	NC	No internal connection	I	
8	GND	Ground		



PINOUT

TFDU4101
Weight 200 mg

"U" Option Baby Face (universal)

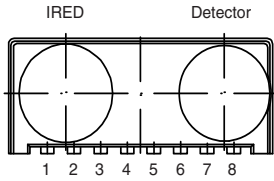

17087

ABSOLUTE MAXIMUM RATINGS

PARAMETER	TEST CONDITIONS	SYMBOL	MIN.	TYP.	MAX.	UNIT
Supply voltage range, transceiver	- 0.3 V < V _{CC2} < 6 V	V _{CC1}	- 0.5		6	V
Supply voltage range, transmitter	- 0.5 V < V _{CC1} < 6 V	V _{CC2}	- 0.5		6	V
Voltage at RXD	- 0.5 V < V _{CC1} < 6 V	V _{RXD}	- 0.5		V _{CC1} + 0.5	V
Voltage at all inputs and outputs	V _{in} > V _{CC1} is allowed	V _{in}	- 0.5		6	V
Input currents	For all pins, except IRED anode pin				10	mA
Output sinking current					25	mA
Power dissipation	See derating curve	P _D			250	mW
Junction temperature		T _J			125	°C
Ambient temperature range (operating)		T _{amb}	- 30		+ 85	°C
Storage temperature range		T _{stg}	- 30		+ 85	°C
Soldering temperature	See "Recommended Solder Profile"				260	°C
Average output current, pin 1		I _{IRED} (DC)			80	mA
Repetitive pulse output current, pin 1 to pin 2	< 90 μs, t _{on} < 20 %	I _{IRED} (RP)			400	mA

Note

- Reference point pin, GND unless otherwise noted. Typical values are for DESIGN AID ONLY, not guaranteed nor subject to production testing.

EYE SAFETY INFORMATION

STANDARD	CLASSIFICATION
IEC/EN 60825-1 (2007-03), DIN EN 60825-1 (2008-05) "SAFETY OF LASER PRODUCTS - Part 1: equipment classification and requirements", simplified method	Class 1
IEC 62471 (2006), CIE S009 (2002) "Photobiological Safety of Lamps and Lamp Systems"	Exempt
DIRECTIVE 2006/25/EC OF THE EUROPEAN PARLIAMENT AND OF THE COUNCIL of 5 th April 2006 on the minimum health and safety requirements regarding the exposure of workers to risks arising from physical agents (artificial optical radiation) (19 th individual directive within the meaning of article 16(1) of directive 89/391/EEC)	Exempt

Note

- Vishay transceivers operating inside the absolute maximum ratings are classified as eye safe according the above table.



ELECTRICAL CHARACTERISTICS						
PARAMETER	TEST CONDITIONS/PINS	SYMBOL	MIN.	TYP.	MAX.	UNIT
TRANSCEIVER						
Supply voltage		V_{CC1}	2.4		5.5	V
Dynamic supply current	SD = low, $E_o = 1 \text{ klx}^{(1)}$, $T_{amb} = -25 \text{ }^\circ\text{C}$ to $+85 \text{ }^\circ\text{C}$ $V_{CC1} = V_{CC2} = 2.4 \text{ V}$ to 5.5 V	I_{CC1}	40	90	130	μA
Dynamic supply current	SD = low, $E_o = 1 \text{ klx}^{(1)}$, $T_{amb} = 25 \text{ }^\circ\text{C}$ $V_{CC1} = V_{CC2} = 2.4 \text{ V}$ to 5.5 V	I_{CC1}	40	75		μA
Average dynamic supply current, transmitting	$I_{RED} = 300 \text{ mA}$, 25 % duty cycle	I_{CC}		0.65	2.5	mA
Shutdown supply current	SD = high, $T = 25 \text{ }^\circ\text{C}$, $E_o = 0 \text{ klx}$ no signal, no resistive load	I_{SD}		0.01	0.1	μA
	SD = high, $T = 70 \text{ }^\circ\text{C}$ no signal, no resistive load	I_{SD}			1	μA
	SD = high, $T = 85 \text{ }^\circ\text{C}$ no signal, no resistive load	I_{SD}			1	μA
Operating temperature range		T_A	- 30		+ 85	$^\circ\text{C}$
Output voltage low, RXD	$C_{load} = 15 \text{ pF}$	V_{OL}	- 0.5		$0.15 \times V_{CC1}$	V
Output voltage high, RXD	$I_{OH} = -500 \text{ } \mu\text{A}$, $C_{Load} = 15 \text{ pF}$	V_{OH}	$0.8 \times V_{CC1}$		$V_{CC1} + 0.5$	V
	$I_{OH} = -250 \text{ } \mu\text{A}$, $C_{Load} = 15 \text{ pF}$	V_{OH}	$0.9 \times V_{CC1}$		$V_{CC1} + 0.5$	V
RXD to V_{CC1} impedance		R_{RXD}	400	500	600	$\text{k}\Omega$
Input voltage low (TXD, SD)		V_{IL}	- 0.5		0.5	V
Input voltage high (TXD, SD)	$1.5 \text{ V} \leq V_{logic} \leq 2.5 \text{ V}^{(2)}$	V_{IH}	$0.8 \times V_{CC1}$		6	V
	$V_{logic} > 2.5 \text{ V}^{(2)}$	V_{IH}	$V_{CC1} - 0.5$		6	V
Input leakage current (TXD, SD)	$V_{in} = 0.9 \times V_{CC1}$	I_{ICH}	- 2		+ 2	μA
Controlled pull down current $0 < V_{in} < 0.15 V_{CC1}$ $V_{in} > 0.7 V_{CC1}$	SD, TXD = "0" or "1"	I_{irTX}	- 1	0	+ 150 1	μA μA
Input capacitance (TXD, SD)		C_I			5	pF

Notes

- $T_{amb} = 25 \text{ }^\circ\text{C}$, $V_{CC1} = V_{CC2} = 2.4 \text{ V}$ to 5.5 V unless otherwise noted.
- Typical values are for DESIGN AID ONLY, not guaranteed nor subject to production testing.
- (1) Standard illuminant A.
- (2) The typical threshold level is $0.5 \times V_{CC1}$. It is recommended to use the specified min./max. values to avoid increased operating current.



OPTOELECTRONIC CHARACTERISTICS (1)						
PARAMETER	TEST CONDITIONS	SYMBOL	MIN.	TYP.	MAX.	UNIT
RECEIVER						
Minimum irradiance E_e in angular range (3) SIR mode	9.6 kbit/s to 115.2 kbit/s $\lambda = 850 \text{ nm to } 900 \text{ nm}; \alpha = 0^\circ, 15^\circ$	$E_{e, \text{min.}}$	4 (0.4)	20 (2)	35 (2) (3.5)	mW/m^2 ($\mu\text{W}/\text{cm}^2$)
Maximum irradiance E_e in angular range (4)	$\lambda = 850 \text{ nm to } 900 \text{ nm}$	$E_{e, \text{max.}}$	5 (500)			kW/m^2 (mW/cm^2)
Rise time of output signal	10 % to 90 %, $C_L = 15 \text{ pF}$	$t_r (\text{RXD})$	20		100	ns
Fall time of output signal	90 % to 10 %, $C_L = 15 \text{ pF}$	$t_f (\text{RXD})$	20		100	ns
RXD pulse width	Input pulse length $> 1.2 \mu\text{s}$	t_{PW}	1.65	2.2	3	μs
Leading edge jitter	Input irradiance = $100 \text{ mW}/\text{m}^2$, $\leq 115.2 \text{ kbit/s}$				250	ns
Standby/shutdown delay, receiver startup time	After shutdown active or power-on				500	μs
Latency		t_L		100	150	μs
TRANSMITTER						
IRED operating current, switched current limiter	No external resistor for current limitation (5)	I_D	250	300	350	mA
Forward voltage of built-in IRED	$I_f = 300 \text{ mA}$	V_f	1.4	1.8	1.9	V
Output leakage IRED current		I_{IRED}	- 1		1	μA
Output radiant intensity	$\alpha = 0^\circ, 15^\circ$ TXD = high, SD = low	I_e	48	65		mW/sr
Output radiant intensity	$V_{\text{CC1}} = 5 \text{ V}, \alpha = 0^\circ, 15^\circ$ TXD = low or SD = high (receiver is inactive as long as SD = high)	I_e			0.04	mW/sr
Output radiant intensity, angle of half intensity		α		± 24		deg
Peak - emission wavelength (6)		λ_p	880		900	nm
Spectral bandwidth		$\Delta\lambda$		45		nm
Optical rise time, optical fall time		$t_{\text{ropt}}, t_{\text{fopt}}$	10		300	ns
Optical output pulse duration	Input pulse width $1.6 \mu\text{s} < t_{\text{TXD}} < 20 \mu\text{s}$	t_{opt}	$t_{\text{TXD}} - 0.15$		$t_{\text{TXD}} + 0.15$	μs
Optical output pulse duration	Input pulse width $t_{\text{TXD}} \geq 20 \mu\text{s}$	t_{opt}		20	300	μs
Optical overshoot					25	%

Notes

- (3) $T_{\text{amb}} = 25^\circ\text{C}$, $V_{\text{CC1}} = V_{\text{CC2}} = 2.4 \text{ V to } 5.5 \text{ V}$ unless otherwise noted.
Typical values are for DESIGN AID ONLY, not guaranteed nor subject to production testing.
- (4) IrDA specification is $40 \text{ mW}/\text{m}^2$. Specification takes a window loss of 10 % into account.
- (5) IrDA sensitivity definition: minimum irradiance E_e in angular range, power per unit area. The receiver must meet the BER specification while the source is operating at the minimum intensity in angular range into the minimum half-angular range at the maximum link length.
- (6) Maximum irradiance E_e in angular range, power per unit area. The optical delivered to the detector by a source operating at the maximum intensity in angular range at minimum link length must not cause receiver overdrive distortion and possible related link errors. If placed at the active output interface reference plane of the transmitter, the receiver must meet its bit error ratio (BER) specification.
- (7) Using an external current limiting resistor is allowed and recommended to reduce IRED intensity and operating current when current reduction is intended to operate at the IrDA low power conditions. E.g. for $V_{\text{CC2}} = 3.3 \text{ V}$ a current limiting resistor of $R_S = 56 \Omega$ will allow a power minimized operation at IrDA low power conditions.
- (8) Due to this wavelength restriction compared to the IrDA spec of 850 nm to 900 nm the transmitter is able to operate as source for the standard remote control applications with codes as e.g. Phillips RC5/RC6® or RECS 80.

For more definitions see the document "Symbols and Terminology" on the Vishay website.

RECOMMENDED CIRCUIT DIAGRAM

Operated with a clean low impedance power supply the TFDU4101 needs no additional external components. However, depending on the entire system design and board layout, additional components may be required (see figure 1). That is especially the case when separate power supplies are used for bench tests. When using compact wiring and regulated supplies as e. g. in phone applications in most cases no external components are necessary.



Fig. 1 - Recommended Test Circuit

Note

¹⁾ R1 is optional when reduced intensity is used.

The capacitor C1 is buffering the supply voltage and eliminates the inductance of the power supply line. This one should be a Tantalum or other fast capacitor to guarantee the fast rise time of the IRED current. The resistor R1 is the current limiting resistor, which may be used to reduce the operating current to levels below the specified controlled values for saving battery power.

Vishay's transceivers integrate a sensitive receiver and a built-in power driver. The combination of both needs a careful circuit board layout. The use of thin, long, resistive and inductive wiring should be avoided. The shutdown input must be grounded for normal operation, also when the

shutdown function is not used.

The inputs (TXD, SD) and the output RXD should be directly connected (DC-coupled) to the I/O circuit. The capacitor C2 combined with the resistor R2 is the low pass filter for smoothing the supply voltage. R2, C1 and C2 are optional and dependent on the quality of the supply voltages V_{CC1} and injected noise. An unstable power supply with dropping voltage during transmission may reduce the sensitivity (and transmission range) of the transceiver.

The placement of these parts is critical. It is strongly recommended to position C2 as close as possible to the transceiver power supply pins.

When extended wiring is used (bench tests!) the inductance of the power supply can cause dynamically a voltage drop at V_{CC2} . Often some power supplies are not able to follow the fast current rise time. In that case another 4.7 μ F (type, see table under C1) at V_{CC2} will be helpful.

Under extreme EMI conditions as placing an RF-transmitter antenna on top of the transceiver, we recommend to protect all inputs by a low-pass filter, as a minimum a 12 pF capacitor, especially at the RXD port. The transceiver itself withstands EMI at GSM frequencies above 500 V/m. When interference is observed, the wiring to the inputs picks it up. It is verified by DPI measurements that as long as the interfering RF - voltage is below the logic threshold levels of the inputs and equivalent levels at the outputs no interferences are expected.

One should keep in mind that basic RF-design rules for circuit design should be taken into account. Especially longer signal lines should not be used without termination. See e.g. "The Art of Electronics" Paul Horowitz, Winfield Hill, 1989, Cambridge University Press, ISBN: 0521370957.

TABLE 1 - RECOMMENDED TESTS AND APPLICATION CIRCUIT COMPONENTS		
COMPONENT	RECOMMENDED VALUE	VISHAY PART NUMBER
C1	4.7 μ F, 16 V	293D 475X9 016B
C2	0.1 μ F, ceramic	VJ 1206 Y 104 J XXMT
R1	Depends on current to be adjusted, e. g. with $V_{CC2} = 3.3$ V 56 Ω is an option for minimum low power operation	
R2	47 Ω , 0.125 W	CRCW-1206-47R0-F-RT1

Figure 2 shows an example of a typical application with a separate supply voltage V_S and using the transceiver with the IRED anode connected to the unregulated battery V_{batt} . This method reduces the peak load of the regulated power supply and saves therefore costs. Alternatively all supplies can also be tied to only one voltage source. R1 and C1 are not used in this case and are depending on the circuit design in most cases not necessary.

In figure 2 an option is shown to operate the transmitter at two different power levels to switch for long range to low

power mode for e.g. saving power for IrDA application but use the full range specification for remote control. The additional components are marked in the figure.

For operating at RS232 ports TOIM4232 is recommended as ENDEC.

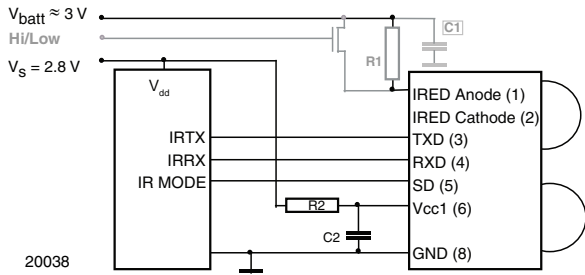

Fig. 2 - Typical Application Circuit
Grey: Optional for High/Low Switching

I/O AND SOFTWARE

In the description, already different I/Os are mentioned. Different combinations are tested and the function verified with the special drivers available from the I/O suppliers. In special cases refer to the I/O manual, the Vishay application notes, or contact directly Vishay Sales, Marketing or Application.

CURRENT DERATING DIAGRAM

Figure 3 shows the maximum operating temperature when the device is operated without external current limiting resistor.

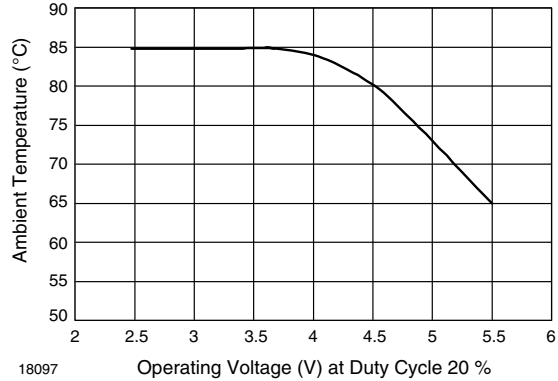

Fig. 3 - Current Derating Diagram

TABLE 2 - TRUTH TABLE					
INPUTS			OUTPUTS		REMARK
SD	TXD	OPTICAL INPUT IRRADIANCE mW/m ²	RXD	TRANSMITTER	OPERATION
High > 1 ms	x	x	Weakly pulled (500 kΩ) to V _{CC1}	0	Shutdown
Low	High < 50 μs	x	Low active	I _e	Transmitting
	High > 50 μs	x	High inactive	0	Protection is active
	Low	< 4	High inactive	0	Ignoring low signals below the IrDA defined threshold for noise immunity
	Low	> min. irradiance E _e < max. irradiance E _e	Low (active)	0	Response to an IrDA compliant optical input signal
	Low	> max. irradiance E _e	Undefined	0	Overload conditions can cause unexpected outputs

RECOMMENDED SOLDER PROFILES

Solder Profile for Sn/Pb Soldering

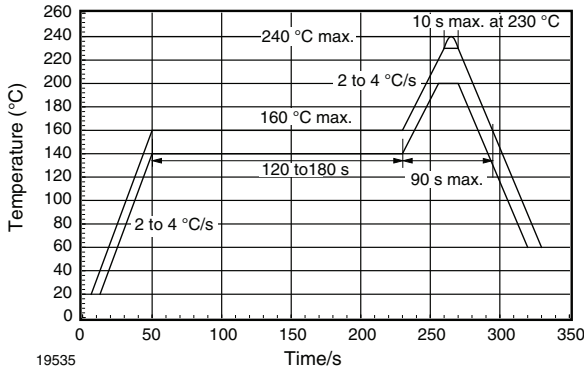

Fig. 4 - Recommended Solder Profile for Sn/Pb Soldering

Lead (Pb)-free, Recommended Solder Profile

The TFDU4101 is a lead (Pb)-free transceiver and qualified for lead (Pb)-free processing. For lead (Pb)-free solder paste like Sn_(3.0-4.0)Ag_(0.5-0.9)Cu, there are two standard reflow profiles: Ramp-Soak-Spike (RSS) and Ramp-To-Spike (RTS). The Ramp-Soak-Spike profile was developed primarily for reflow ovens heated by infrared radiation. With widespread use of forced convection reflow ovens the Ramp-To-Spike profile is used increasingly. Shown below in figure 5 and 6 are Vishay's recommended profiles for use with the TFDU4101 transceivers. For more details please refer to the application note "SMD Assembly Instructions". A ramp-up rate less than 0.9 °C/s is not recommended. Ramp-up rates faster than 1.3 °C/s could damage an optical part because the thermal conductivity is less than compared to a standard IC.

Wave Soldering

For TFDUxxxx and TFBSxxxx transceiver devices wave soldering is not recommended.

Manual Soldering

Manual soldering is the standard method for lab use. However, for a production process it cannot be recommended because the risk of damage is highly dependent on the experience of the operator. Nevertheless, we added a chapter to the above mentioned application note, describing manual soldering and desoldering.

Storage

The storage and drying processes for all Vishay transceivers (TFDUxxxx and TFBSxxx) are equivalent to MSL4. The data for the drying procedure is given on labels on the packing and also in the application note "Taping, Labeling, Storage and Packing".

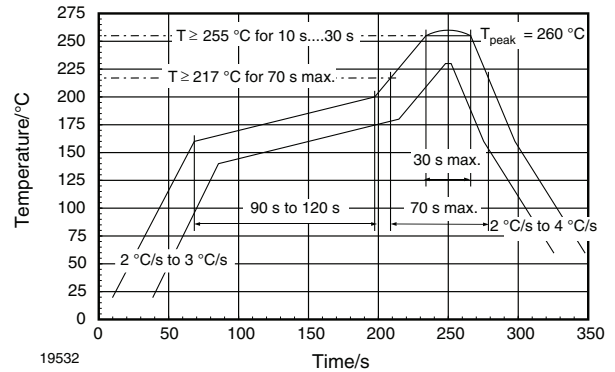

Fig. 5 - Solder Profile, RSS Recommendation

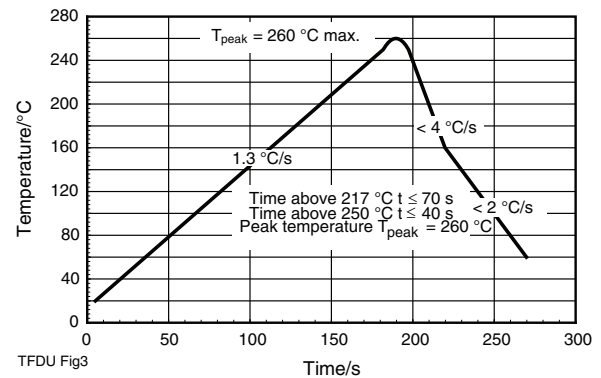

Fig. 6 - RTS Recommendation



Fig. 9 - Recommended Footprint for Top View Applications and Solderpaste Mask

REEL DIMENSIONS in millimeters



Drawing-No.: 9.800-5090.01-4
Issue: 1; 29.11.05

14017

Form of the leave open
of the wheel is supplier specific.

Dimension acc. to IEC EN 60 286-3

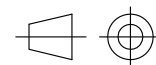

technical drawings
according to DIN
specifications

TAPE WIDTH (mm)	A MAX. (mm)	N (mm)	W ₁ MIN. (mm)	W ₂ MAX. (mm)	W ₃ MIN. (mm)	W ₃ MAX. (mm)
24	330	60	24.4	30.4	23.9	27.4

TAPE DIMENSIONS in millimeters

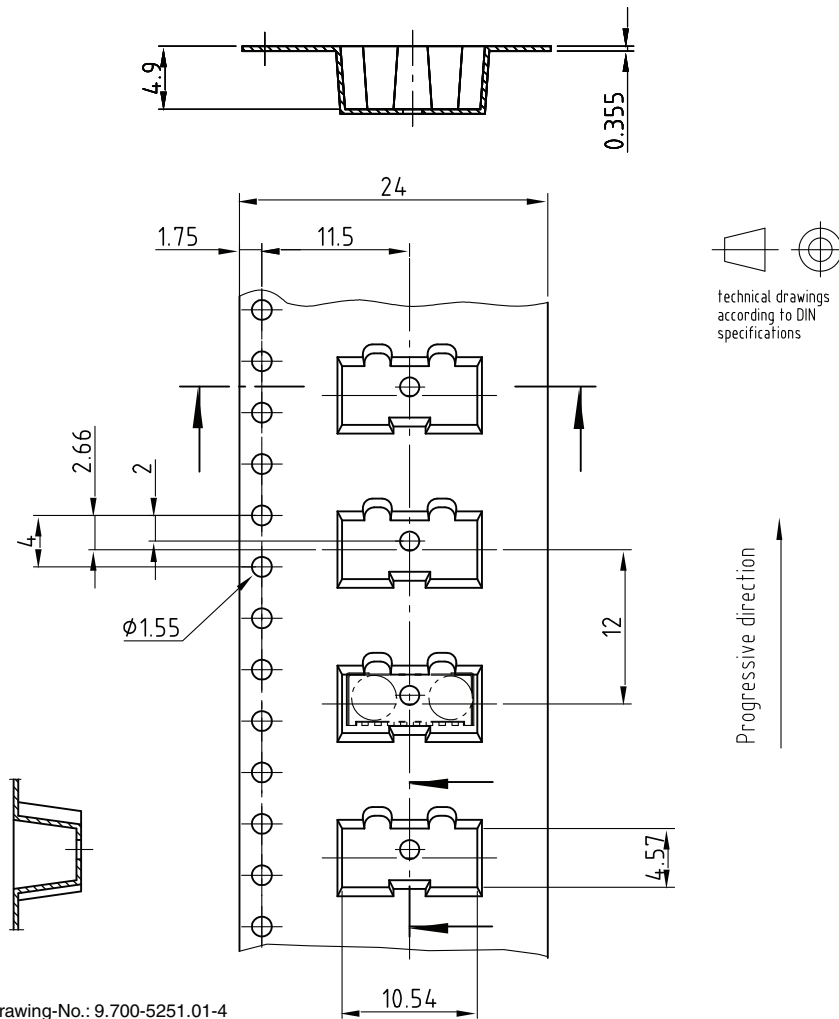

Drawing-No.: 9.700-5251.01-4
 Issue: 3; 02.09.05
 19824

Fig. 10 - Tape Drawing, TFDU4101 for Top View Mounting, Tolerance ± 0.1 mm

HANDLING PRECAUTION

Sagging of carrier tape may cause some units to rotate and will result to pick-and-place problem. Do not allow carrier tape to sag as shown in picture below.





Drawing-No.: 9.700-5297.01-4

Issue: 3; 21.12.05

19875

Fig. 11 - Tape Drawing, TFDU4101 for Side View Mounting, Tolerance ± 0.1 mm



Disclaimer

ALL PRODUCT, PRODUCT SPECIFICATIONS AND DATA ARE SUBJECT TO CHANGE WITHOUT NOTICE TO IMPROVE RELIABILITY, FUNCTION OR DESIGN OR OTHERWISE.

Vishay Intertechnology, Inc., its affiliates, agents, and employees, and all persons acting on its or their behalf (collectively, "Vishay"), disclaim any and all liability for any errors, inaccuracies or incompleteness contained in any datasheet or in any other disclosure relating to any product.

Vishay makes no warranty, representation or guarantee regarding the suitability of the products for any particular purpose or the continuing production of any product. To the maximum extent permitted by applicable law, Vishay disclaims (i) any and all liability arising out of the application or use of any product, (ii) any and all liability, including without limitation special, consequential or incidental damages, and (iii) any and all implied warranties, including warranties of fitness for particular purpose, non-infringement and merchantability.

Statements regarding the suitability of products for certain types of applications are based on Vishay's knowledge of typical requirements that are often placed on Vishay products in generic applications. Such statements are not binding statements about the suitability of products for a particular application. It is the customer's responsibility to validate that a particular product with the properties described in the product specification is suitable for use in a particular application. Parameters provided in datasheets and/or specifications may vary in different applications and performance may vary over time. All operating parameters, including typical parameters, must be validated for each customer application by the customer's technical experts. Product specifications do not expand or otherwise modify Vishay's terms and conditions of purchase, including but not limited to the warranty expressed therein.

Except as expressly indicated in writing, Vishay products are not designed for use in medical, life-saving, or life-sustaining applications or for any other application in which the failure of the Vishay product could result in personal injury or death. Customers using or selling Vishay products not expressly indicated for use in such applications do so at their own risk. Please contact authorized Vishay personnel to obtain written terms and conditions regarding products designed for such applications.

No license, express or implied, by estoppel or otherwise, to any intellectual property rights is granted by this document or by any conduct of Vishay. Product names and markings noted herein may be trademarks of their respective owners.

Material Category Policy

Vishay Intertechnology, Inc. hereby certifies that all its products that are identified as RoHS-Compliant fulfill the definitions and restrictions defined under Directive 2011/65/EU of The European Parliament and of the Council of June 8, 2011 on the restriction of the use of certain hazardous substances in electrical and electronic equipment (EEE) - recast, unless otherwise specified as non-compliant.

Please note that some Vishay documentation may still make reference to RoHS Directive 2002/95/EC. We confirm that all the products identified as being compliant to Directive 2002/95/EC conform to Directive 2011/65/EU.

Vishay Intertechnology, Inc. hereby certifies that all its products that are identified as Halogen-Free follow Halogen-Free requirements as per JEDEC JS709A standards. Please note that some Vishay documentation may still make reference to the IEC 61249-2-21 definition. We confirm that all the products identified as being compliant to IEC 61249-2-21 conform to JEDEC JS709A standards.